



TS-C 30-700/T-EN54

- Aluminium housing
- Weather-proof
- BS 5839



EN 54-24:2008

Ref. Nr.: 006-13

ID-Code: SAA-LS06
1438/CPD/0315

ic audio GmbH, Boehringerstraße 14a,
D-68307 Mannheim, Germany

CE-Symbol gemäß Richtlinie 93/68EWG

The 30W powered speaker is equipped with six 77mm full-range loudspeaker chassis and a 100V transformer with 3 power adjustments. The powder-coated and shock-resistant aluminium housing in RAL 9006 guarantees long-term stability. For additional reliability, a 2-pin ceramic block, and a thermal fuse is provided and the speaker chassis is impregnated against wetness. Furthermore, sturdy cable glands 2 x PG9 are also provided. The speaker is also secured with the high protection class IP 66 against the security risks of environmental influences.

The speaker is compliant with the British Standard BS 5839, Part 8. The easy mounting with the included swivel bracket provides much flexibility for the installation. Special paint of the speaker in 4-digit RAL or NCS colour is available at extra cost.

The ball impact resistance of the sound column can only be guaranteed if a mounting bracket is used (article number 20132684). This can be ordered separately.

Technical Data (Electrical)

Description	TS-C 30-700/T-EN54
Power	30/15/7.5 W
Impedance (100V)	333/667/1333 ohm
Frequency Range	230 - 16.500 Hz
Frequency Response	137 - 23.500 Hz
SPL IEC268-5, 1W/1m	93,0 dB
SPL EN54-24, Pmax/4m	96,7 dB
Sensitivity EN54-24, 1W/4m	81,0 dB
Sensitivity EN54-24, 1W/1m	93,0 dB
Dispersion -6dB, 500Hz	h=360°, v=114°
Dispersion -6dB, 1KHz	h=190°, v=50°
Dispersion -6dB, 2KHz	h=160°, v=26°
Dispersion -6dB, 4KHz	h=85°, v=13°

Technical Data (Mechanical)

Dimensions	700x100x92 mm
IP Rating	IP66
Weight (net)	3,80 kg
Temperature Range	-25 / +70 C°
Mounting	Swivel bracket
Horizontal Adjustment	-75°...+75° (5° steps)
Vertical Adjustment	-45°...+60° (5° steps)
Connector	2 x 2-pin ceramic block
Terminal Diameter	4,0 mm
Maximum Cable Passage	8 mm ²
Colour	RAL 9006

Product Attributes

Technical Drawing



TS-C 30-700/T-EN54

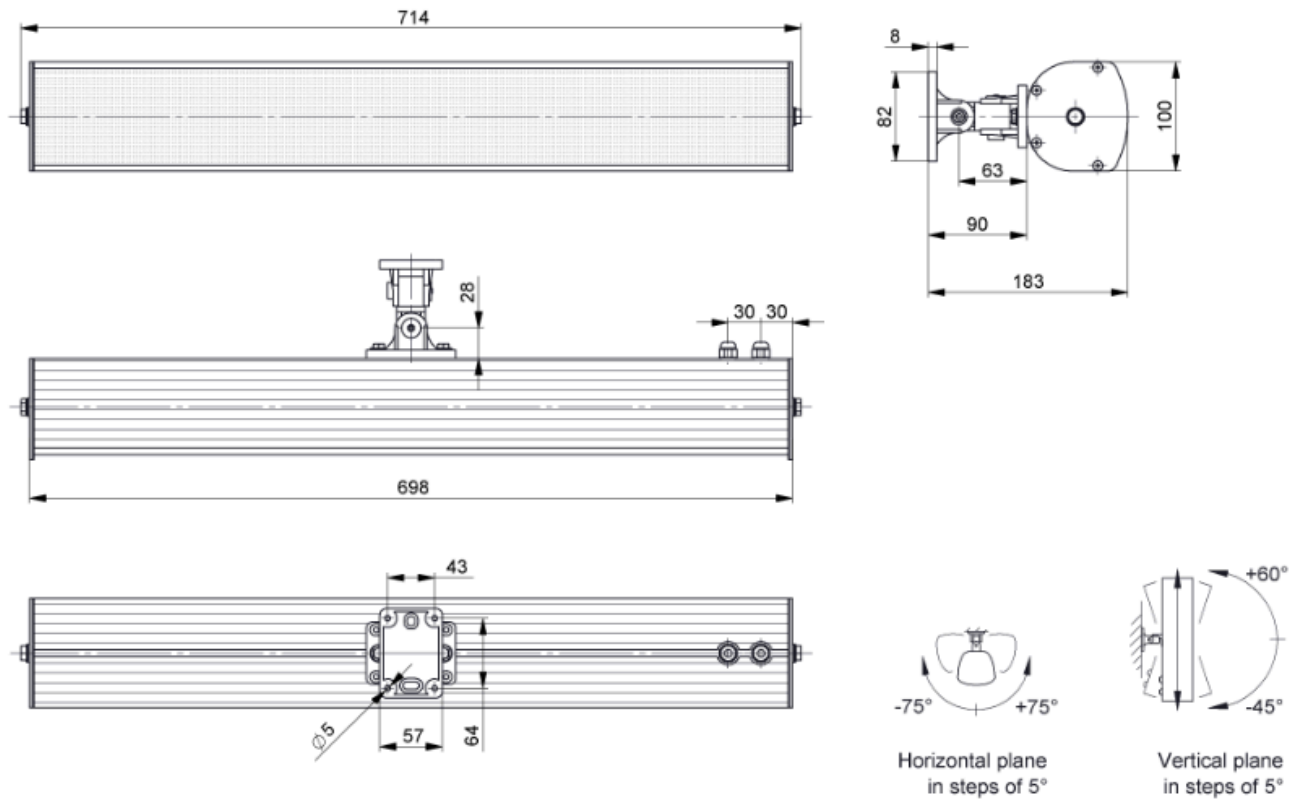

all dimensions are in mm

Frequency Response Diagram

Sensitivity

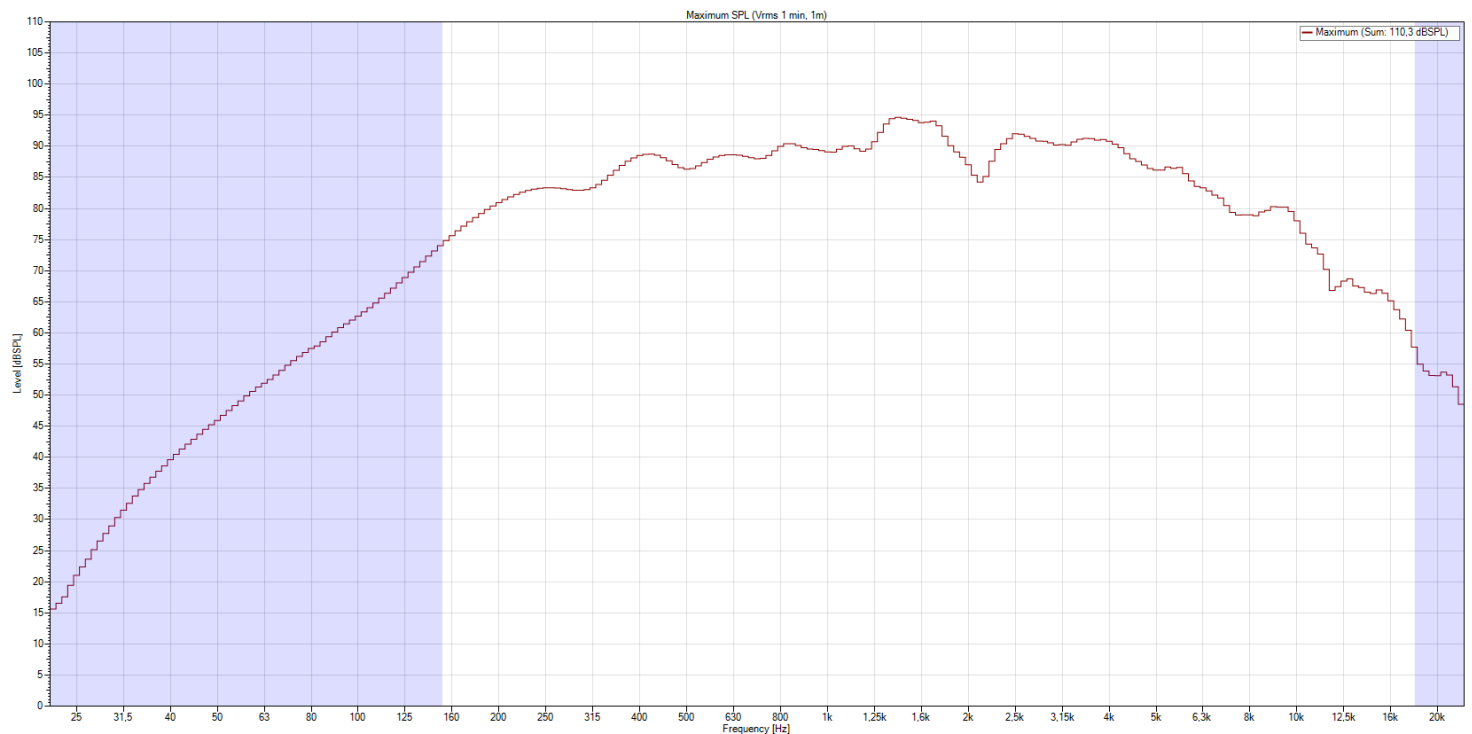
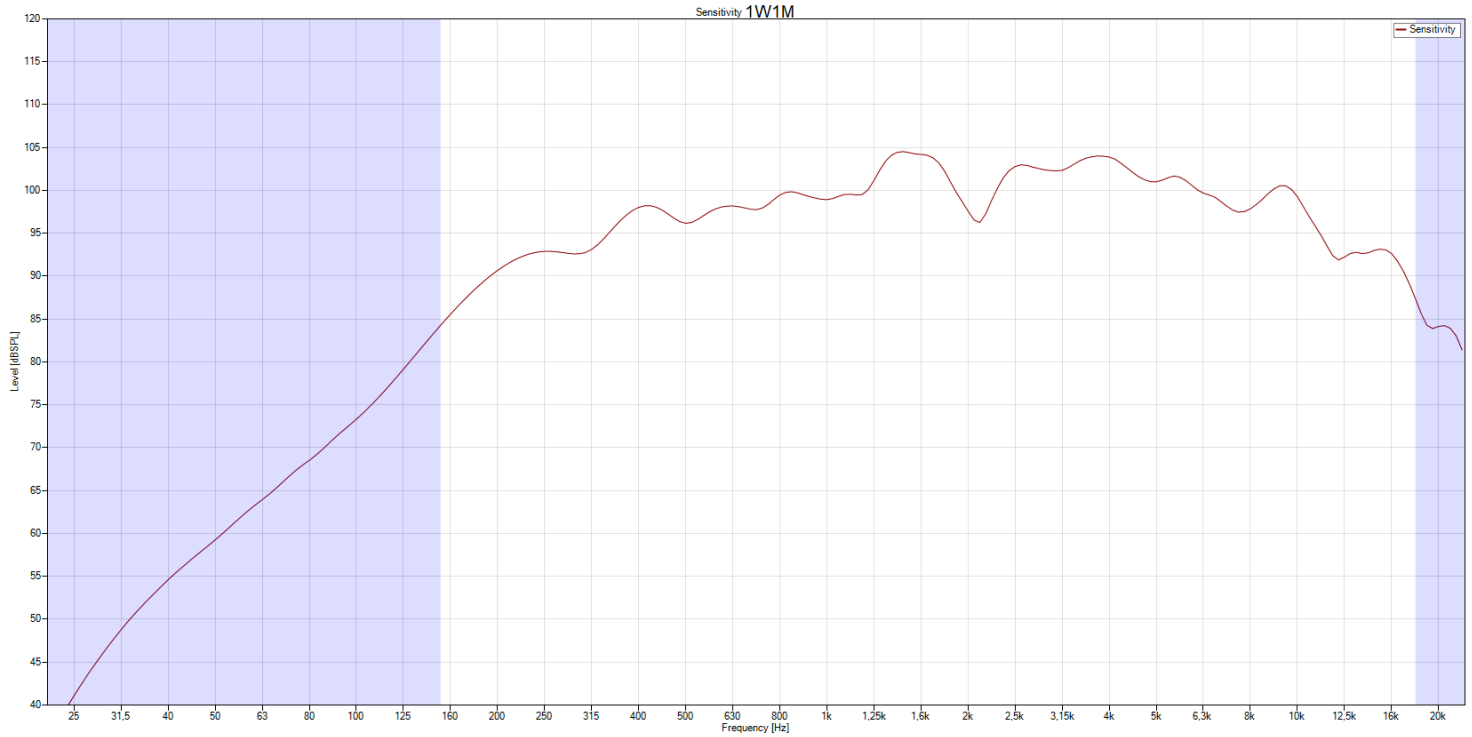

Isobar

Vertical

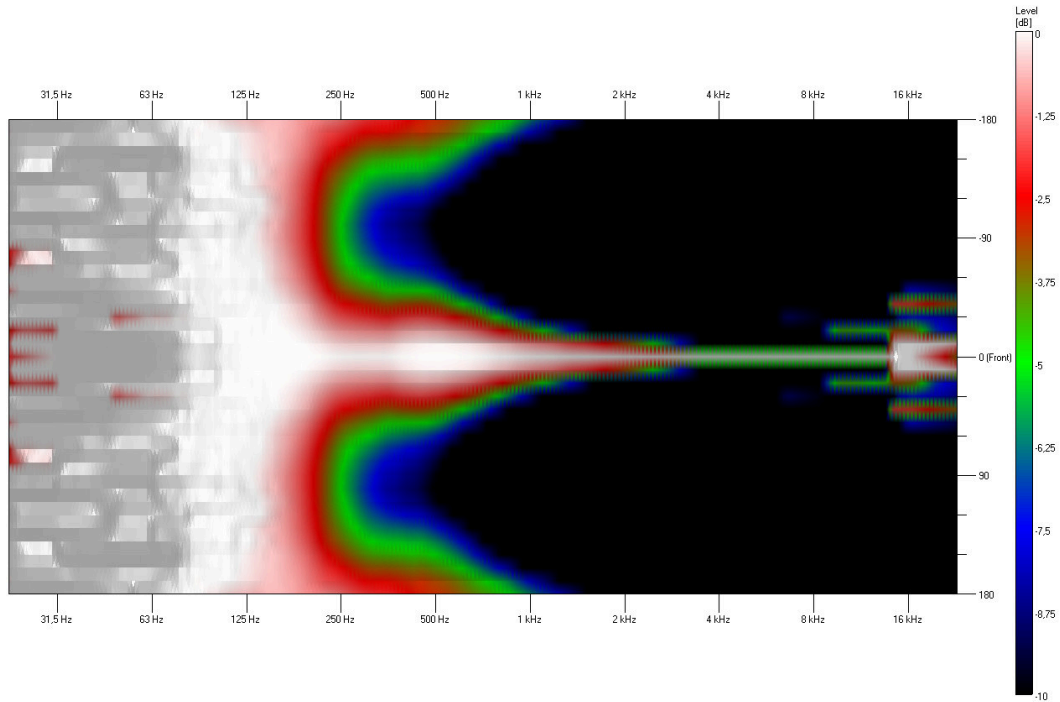

Horizontal

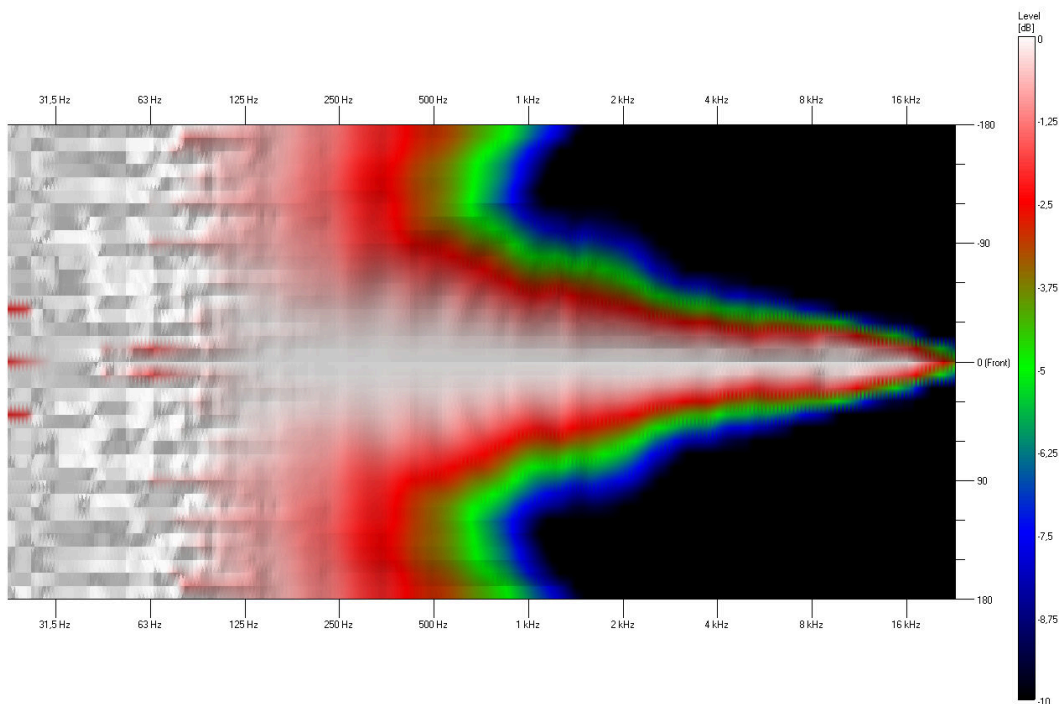

Polar Diagram

Polar Diagram 500Hz

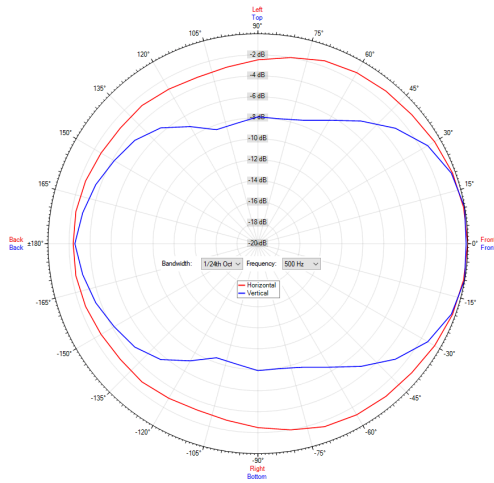

Polar Diagram 4000Hz

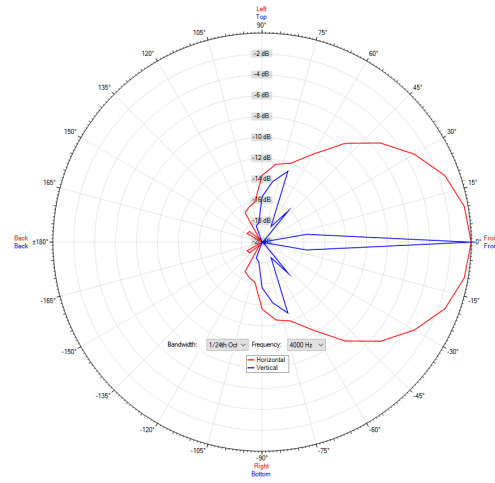

Polar Diagram 1000Hz

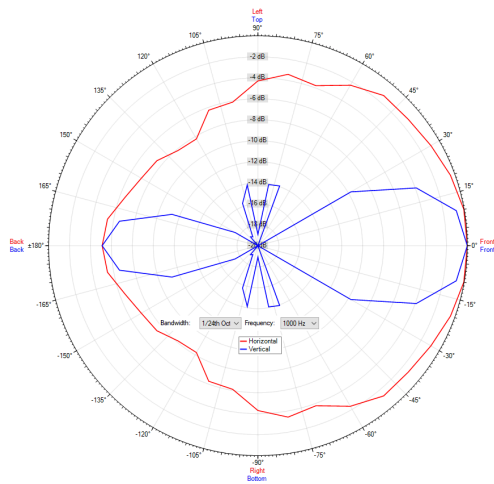

Polar Diagram 8000Hz

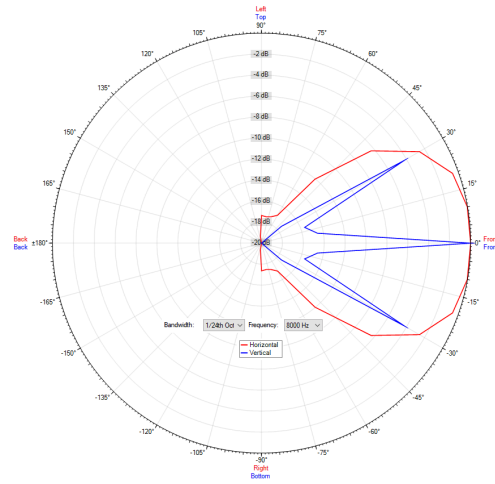

Polar Diagram 2000Hz

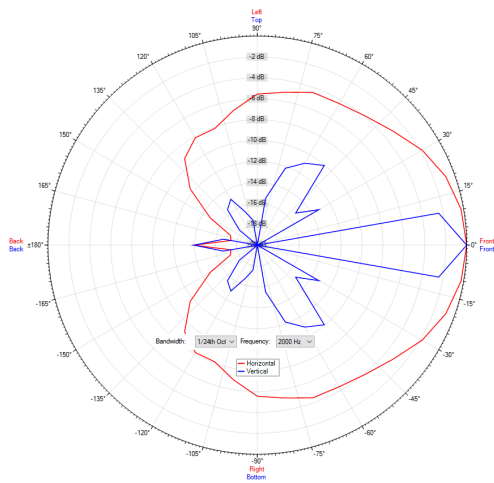

ic audio loudspeakers are tested and classified according to the IEC standard 60529 (degree of protection by enclosure) against the penetration of foreign objects and moisture. The classification is conforming to standards through characterization with a fixed code. This code consists of the letters IP (International Protection) followed by two digits. The first digit indicates the degree of protection against dust and the second digit the degree of protection against water. Please note that the testing of the products has been carried out in laboratory conditions which are not always 100% comparable with the conditions of different installation environments. This protection can be reduced due to normal wear and tear depending on the installation environment.

RoHS compliant (2011/65/EU)

The IP rating specified is based on ic audio test results, not on CNBOP-PIB test results. Certification only verifies the minimum requirements for EN54-24 compliance.



Article Nr.: 20122603
Packing Unit: 1

